

SUSSEX

Sussex Oria Cross Wall Basin Set 215mm - Step 1: Rough in

Tapware is to be installed by a Licensed Plumber in accordance with AS/NZS 3500:2003
 Recommended working water pressure 300 - 500 Kpa. Maximum water temperature is 65°C

ROUGH-IN OPTION 1: Installing tapware into a new Wall Breech

- A standard Plumbing Wall Breech (not supplied) is to be used in conjunction with this Tapware.
- Secure a nogging **45mm (i)** back from the front of the stud. Attach the Wall Breech to the nogging.
- Ensure the Breech Tap Seat Bodies are square and parallel between the Wall Studs.
- For the Tapware to fit correctly, the thickness of the finished Wall coverings is calculated between **20mm** and **35mm (ii)**.
- The Tap Seat Body of the Breech **MUST** be a minimum of **10mm** and a maximum of **30mm (iii)** back from the finished wall coverings.
- Once the finished wall coverings are in place - the breech outlet connector should protrude no further than **25mm** and no less than **112mm (iv)**.
- If the finished wall coverings and Tap Seat Body do not sit within the range specified. Please contact manufacturer.

ROUGH-IN OPTION 2: Changing Tapware Only. Installing into an existing Wall Breech

- Remove the old Spindles and clean surrounding area.
- Use a re-seating tool to dress the Seat and ensure the Spindle Seat is clean, flat and free of any debris.
- Ensure the Breech Tap Seat Bodies are square and parallel between the Wall Studs.
- The Tap Seat Body of the Breech **MUST** be a minimum of **10mm** and a maximum of **30mm (iii)** back from the finished wall coverings.
- If the finished wall coverings and Tap Seat Body do not sit within the range specified. Please contact manufacturer.

Part	Part Name
A	Handle Assembly - Handle (A1) and Flange (A2)
B	Spindle Hex Adapter
C	50mm Locknut
D	Fibre Washer
E	90mm Spindle
F	Outlet Assembly - Outlet (F1) and Flange (F2)
G	Set Screw

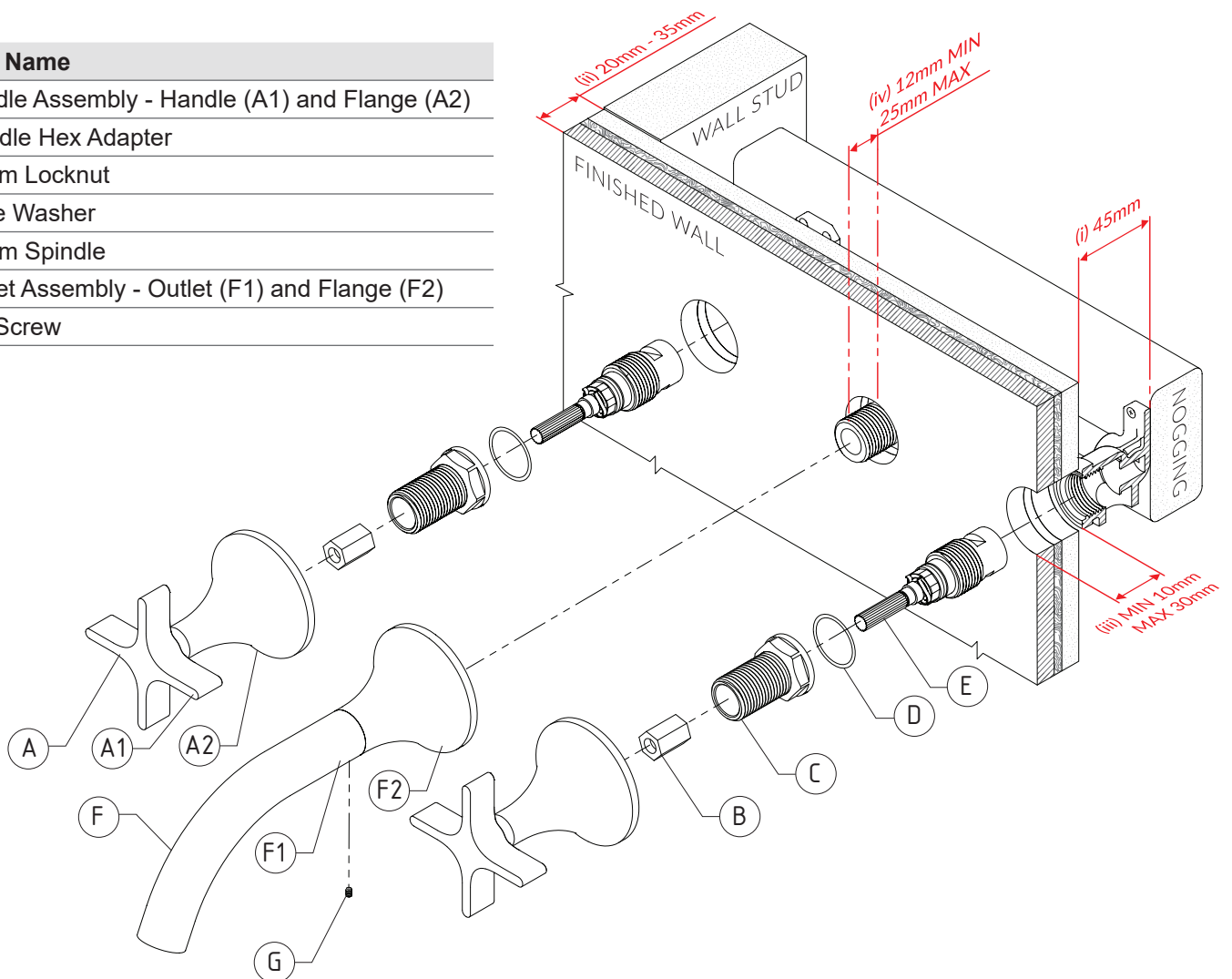

SUSSEX

Sussex Oria Cross Wall Basin Set 215mm - Step 2: Handle Fit off

1) Screw Spindle (E) into the Tap Seat Body **by hand** until the seat is felt. Tighten with an additional 1/3 turn of a spanner. **DO NOT OVER TIGHTEN.**

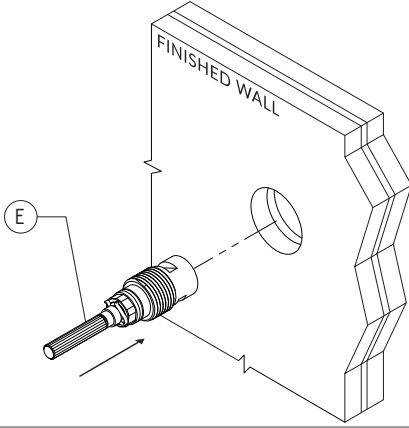

2) Once Fitted, Ensure both spindles (E) are set to **OFF** position - **HOT = FULL TURN CLOCKWISE** and **COLD = FULL TURN ANTICLOCKWISE.**

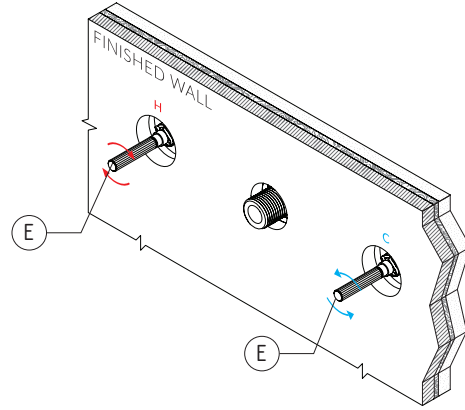

3) Fit Fibre Washer (D) and screw Locknut (C) onto Spindle (E) for measurement.

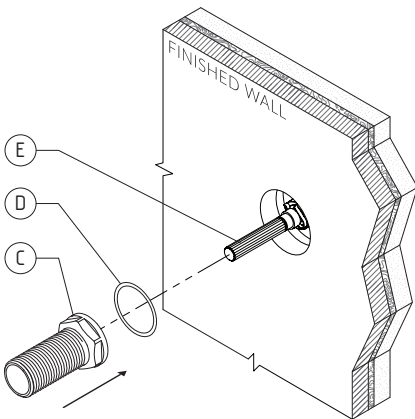

4) Measure the amount of Locknut (C) thread protruding from the finished wall and mark between **15-20mm.**

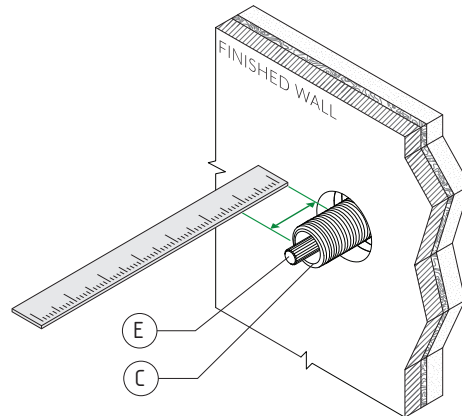

5) Unscrew Locknut (C) cut and Deburr prior to re-fitting onto spindle and tightening well.

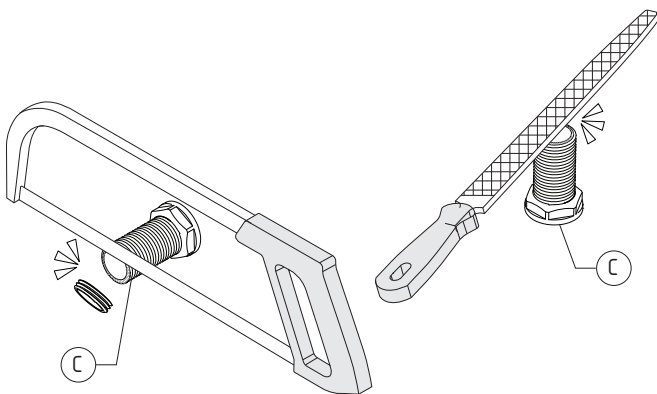

6) Measure Spindle length protruding from finished wall. This should measure between **25mm** and **30mm.** Cut if necessary.

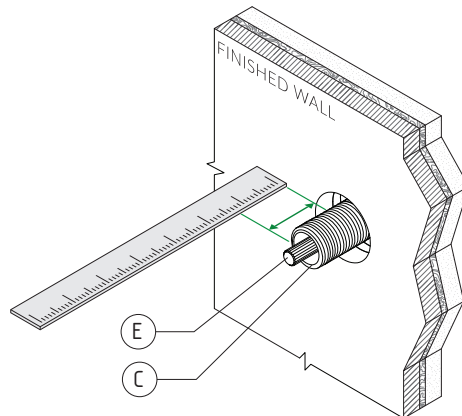

SUSSEX

Sussex Oria Cross Wall Basin Set 215mm - Step 2: Handle Fit off cont'd

7) Cut Spindle (E) and deburr prior to next step.

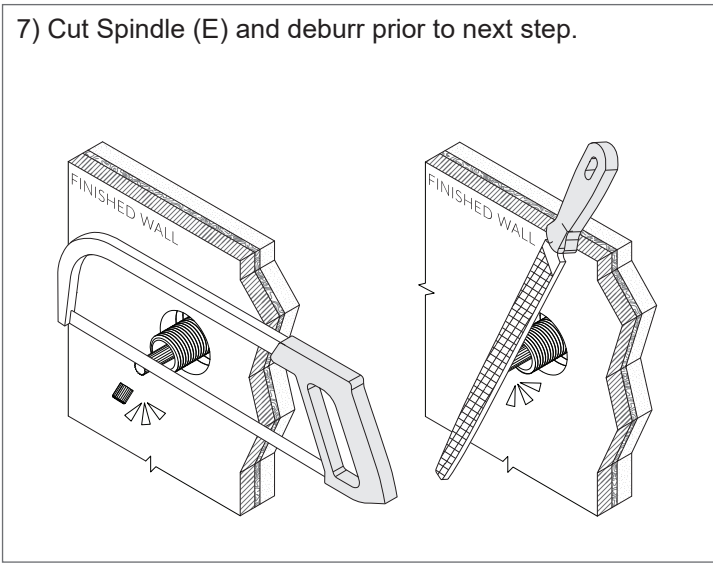

8) Seal the wall penetration. Affix Spindle Hex Adapter (B) to spindle (E) align the handle (A1) horizontally and slide the handle assembly (A) on until the Handle Assembly touches the Locknut thread.

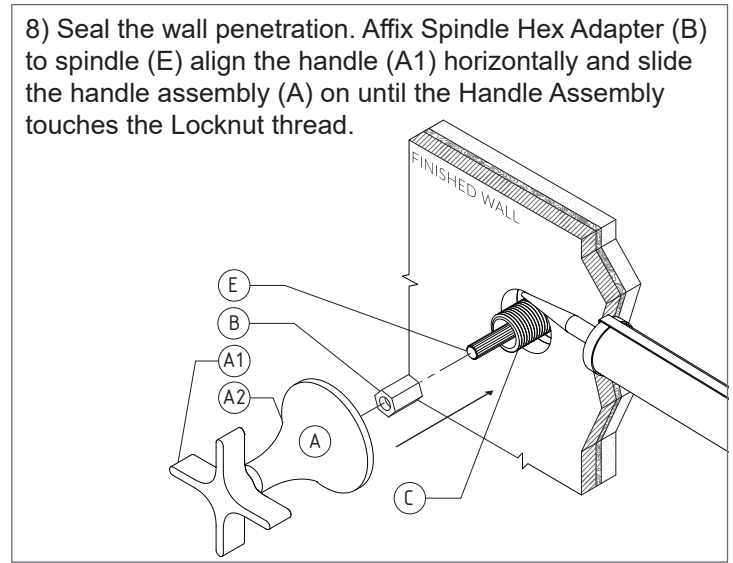

9) The Handle Assembly can be screwed onto the Locknut (C) by rotating the flange (A2).

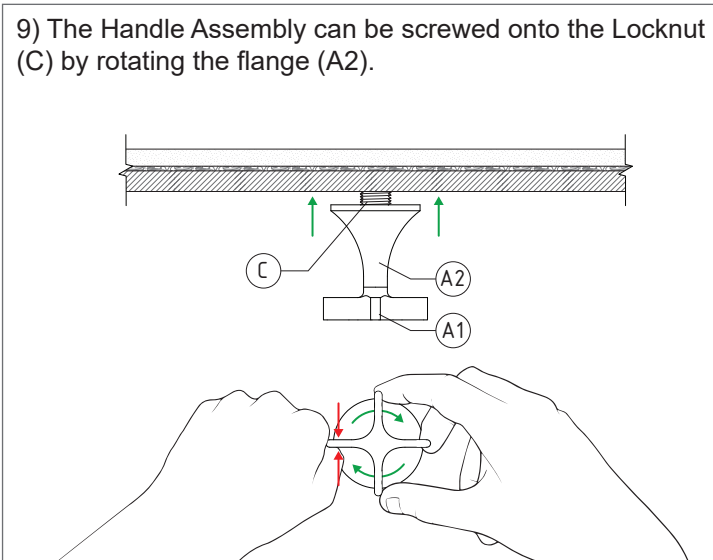

10) The handle must be affixed as shown with the standard "off" position in horizontal alignment.

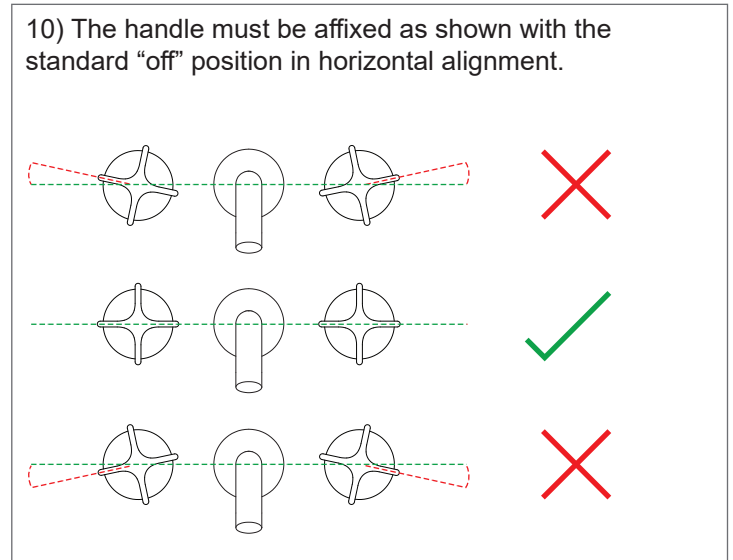

11) If the handle alignment is not correct, remove the Handle Assembly (A) and Spindle Hex Adapter (B) and rotate to engage a different position on the spline.

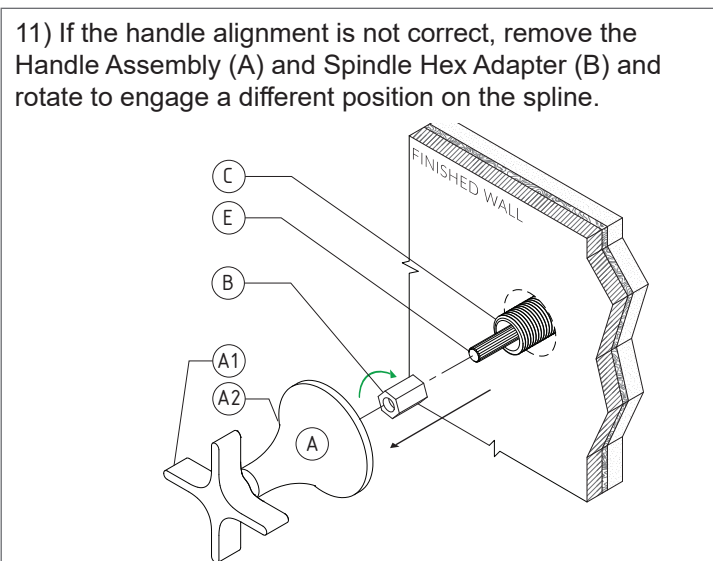

12) Re-fit Spindle Hex Adapter (B) and Handle Assembly (A) Repeat step 9-12 until horizontal handle alignment is achieved.

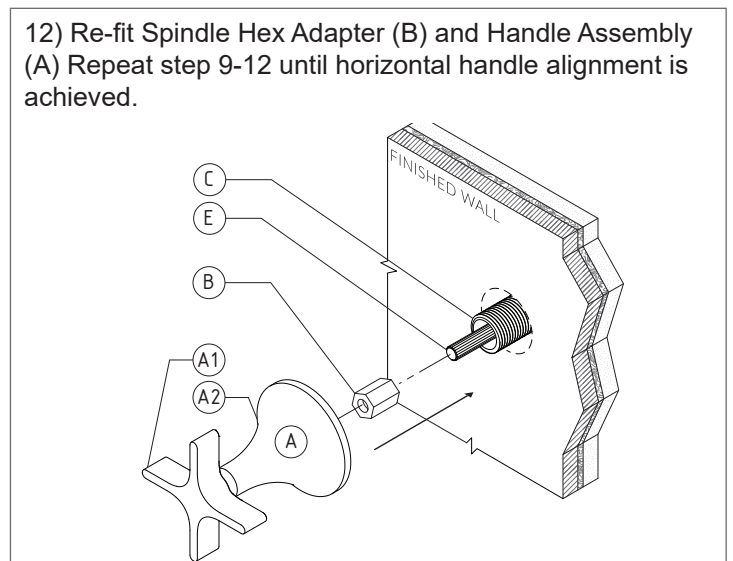

SUSSEX

Sussex Oria Cross Wall Basin Set 215mm - Step 3: Outlet Fit off

13) Separate the Outlet Assembly (F) by loosening the Set Screw (G) this will allow the Flange (F2) To come away from the Outlet (F1).

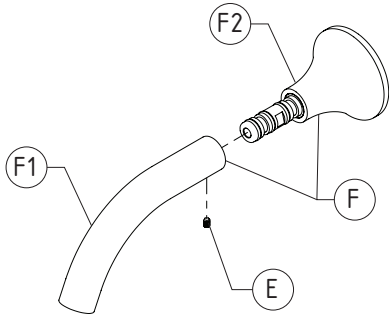

14) Ensure the area is clean and clear of debris. Seal the wall penetration and apply teflon tape or alternative sealant to the wall breach thread.

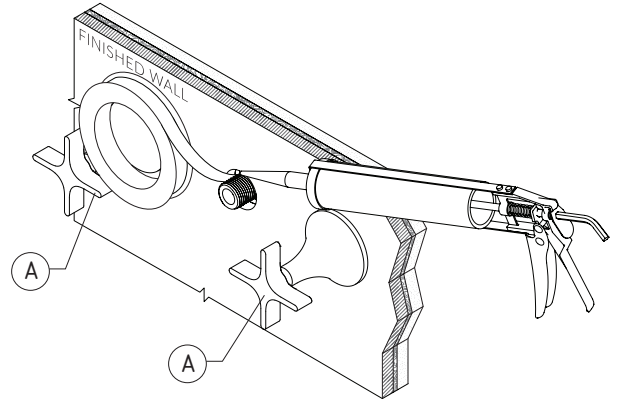

15) Screw the Flange (F2) onto the Wall Breech (1/2" BSP) until it meets the wall.

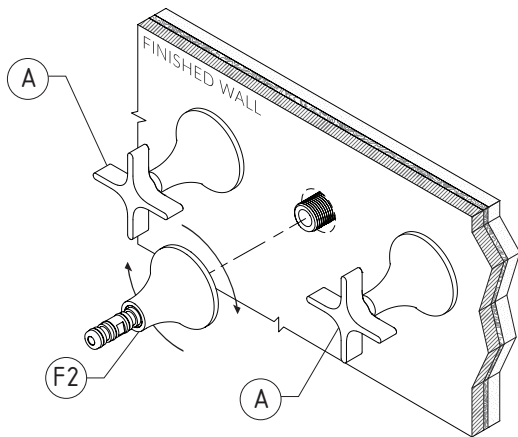

16) Tighten the Flange (F2) by hand and secure with a spanner.

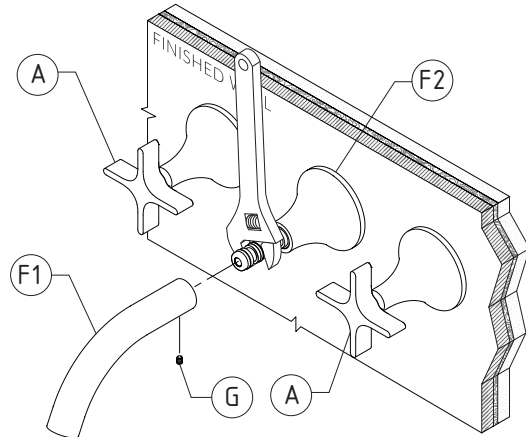

17) Fit the spout (F1) onto the post of the Flange (F2). Align and secure by tightening the set screw (G).

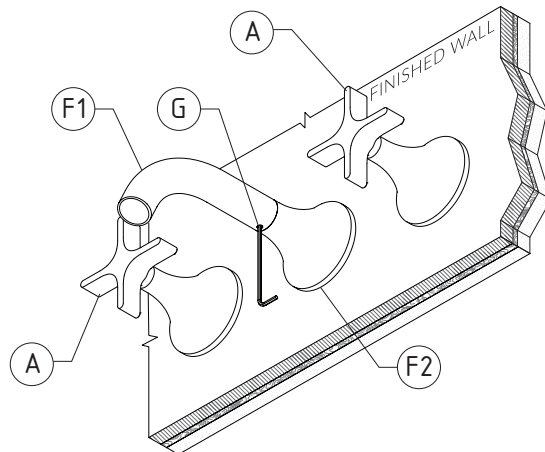

After installation, establish water supply and thoroughly check operation of tapware to ensure that it functions correctly and no water leaks. Plumbers, please ensure a copy of the Installation Instructions are left with the end user for future reference