

Posh Solus Tile Over Shower Tray with 1140mm Long Rear Matte Black Tile Insert Channel Suits Tiles 9mm and up (For 3 Wall / Alcove Install) 900mm x 900mm

9512243

SPECIFICATIONS

Recommended Use	Residential;Commercial
Shower Base Colour	Grey
Shower Base Material	SMC
Shower Grate Material	Stainless Steel (316 Grade)
Waste Position	Centre Rear
Shower Base Waste Size	50 mm
Weight of Shower Base	20 kg
Usage	Alcove Install

WARRANTY

Residential & Commercial Use (Years)	7
Spare Parts & Labour (Years)	1

Please refer to Posh Warranty Page for full Terms and Conditions

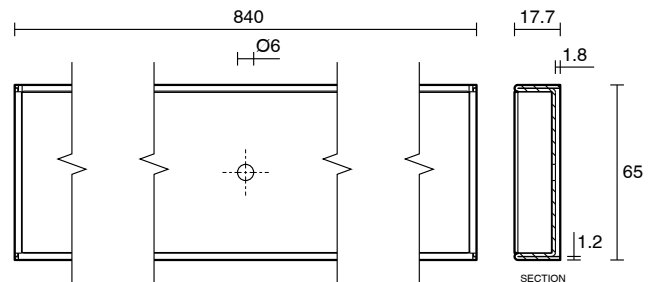
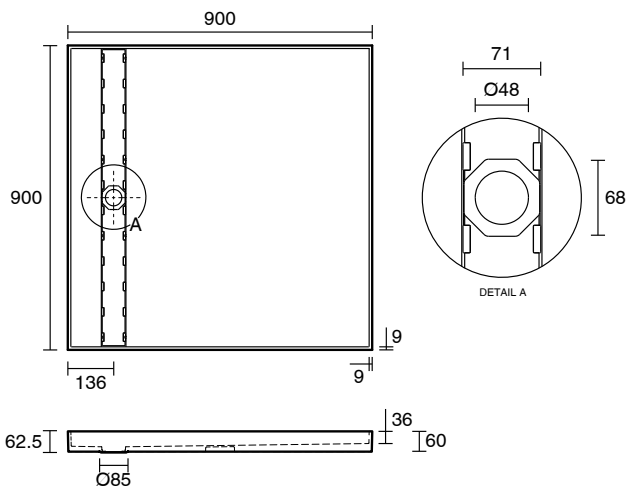

Dimensions are nominal measurements only.

CLEANING RECOMMENDATIONS:

We recommend the use of soapy water or approved cleaners. This product should not be cleaned with abrasive materials. Damage caused by any improper treatment is not covered by the product warranty. Refer to Warranty Conditions

Disclaimer: Products in this specification manual must by regulation be installed by licensed and registered trade people. The manufacturer/distributor reserves the right to vary specifications or delete models from their range without prior notification. Dimensions are nominal measurements only. Dimensions and set-outs listed are correct at time of publication however the manufacturer/distributor takes no responsibility for printing errors.

Published 01/04/2026

To see the complete Posh range go to
www.reece.com.au