

**FRANKE**



# SINKS & TAPS



# Well-Living is on show



Scan to see our  
brand campaign.

**FRANKE**

# PRODUCT CATALOGUE

## FAMILIES

- 18 Mythos
- 20 Maris
- 22 Smart

## PRODUCT CATEGORIES

### Sinks

- 36 Overview
- 40 Bow Centre
- 42 Brookmore
- 50 Ancona
- 54 Bow
- 60 City
- 72 Rapid

### Taps

- 78 Overview
- 82 Active Twist
- 84 Steel

### Accessories

- 88 Plumbing Kits







# OUR HISTORY

## Over one hundred years of passion

At Franke, we have been looking for new solutions and innovations for over 100 years and our attitude still has not changed. In 1911 we combined traditional craftsmanship, precision engineering and a constant pursuit of innovation, three principles that remain at our core.

## A story forged in Swiss precision

Our story began at the beginning of the last century as a small sheet-metal business in Rorschach, Switzerland, established by Hermann Franke.

Since then, we opened up to the world and inaugurated manufacturing facilities all around the globe that led us to become leaders in the kitchen sinks segment, and home solutions altogether.



# The recipe for a healthier future

We're on a mission to help create a more sustainable planet, one innovation at a time. From designs built with the use of sustainable materials, to efficiency optimisation and waste reduction, we act responsibly throughout our business and beyond for positive long-term impact.



## Taking care of the environment

Our vision is to reach net-zero greenhouse gas (GHG) emissions across our value chain by 2050 from a 2020 base year.

We have established clear goals that support this ambition to contribute to a more sustainable world for our customers, employees, and society.

We developed our near-term and net-zero targets in 2023 in line with the Paris Climate Agreement, and they were validated by the Science Based Targets initiative (SBTi) in February, setting a cornerstone in our sustainability journey.

## Resources

In 2023, we continued the switch from Styrofoam packaging to cardboard for the Franke range of Fr granite and Tectonite material sinks across Franke's distribution centers around the world.

Franke's total share of renewable packaging was 89.9 percent in 2023.

## Waste

75% of waste created in 2022 was reused or recycled.

## Packaging

Franke has switched from Styrofoam to cardboard packaging for its range of granite and tectonite sinks.

91% of Franke packaging is made from renewable materials.

## Creating a proactive safety-first culture

People are at the core of what we do, and their safety needs to be a pre-condition of how we work. This approach is enshrined in our company values and drives our safety and occupational health measures. We view the prevention of physical and mental harm and the promotion of workers' health and wellbeing as a key responsibility in recognition of the fundamental human rights of workers.

**“ We've reduced our scope 1 and 2 emissions for eight years running and our net-zero emissions reduction targets have been validated by the SBTi. ”**

Patrik Wohlhauser, Franke CEO

## Innovation for sustainable living

Our eco-friendly innovations are designed to empower cleaner living at home and inspire everyday wellbeing.

### Taps

Franke's stainless steel taps are made of 100% recyclable steel. In addition, some taps offer the water-saving feature.

This innovative technology allows you to move the handle to a position that will reduce water flow by 50%. In addition, taps equipped with Franke's ECO cartridge are designed to limit the flow and temperature of the water.



### Sinks

Franke's sinks ranges are exemplary in terms of usage of sustainable materials such as stainless steel, Fraganite and ceramic that guarantee extraordinary product durability, resistance and long-lasting quality.

# Experience our new Showroom

Welcome to the Franke's Aarburg Showroom a place of discovery.

It has been key to bring Franke's new positioning to life in the Aarburg showroom concept, as well as in all spaces applying and adapting the new brand style guide. The new colors from primary to a wide modern secondary colors selection has been applied to the display creating a vibrant, fresh and contemporary design combination.

The highlights are our product families Mythos, Maris and Smart representing in the best way Franke as System Provider. Within the showroom there is also an attention to people and their well-being with open and clear understandable demonstration corners in a delightful natural material surrounding.

Franke's innovations are brought into the showroom with a superior quality look, tone and feel, elevating to the fullest the brand and products experience.

## Aarburg Showroom

Franke-Strasse 2  
4663 Aarburg  
Switzerland

Phone: +41 62 787 31 31

Fax: +41 62 787 30 18



Scan  
to view  
the Aarburg  
Showroom





# Explore our digital, interactive catalogue

Our digital catalogue gives you direct access to the entire Franke world – anytime, anywhere.

Whether on your smartphone, tablet or computer, explore our range, review product details and discover inspiration wherever you are – with customers, at home, in the showroom or on the go.

The catalogue is always up to date, featuring the latest products and technical information. Each item links directly to our website, giving you access to further details with just one click. With the intelligent search function, time-consuming page turning becomes a thing of the past.

**Simple to use, easy to share and always available – exactly when you need it.**

## Where is the catalogue available?

- Directly on our website
- Via a direct link in our Partner Portal

## Key benefits

- Direct links to our website for additional product information.
- Internal links within the catalogue for easy navigation
- Intelligent search function for quick access to products and information.
- Zoom functionality to enlarge individual pages.
- Share the catalogue directly from any page.
- Create a customised version of the catalogue.

Explore  
the digital  
catalogue

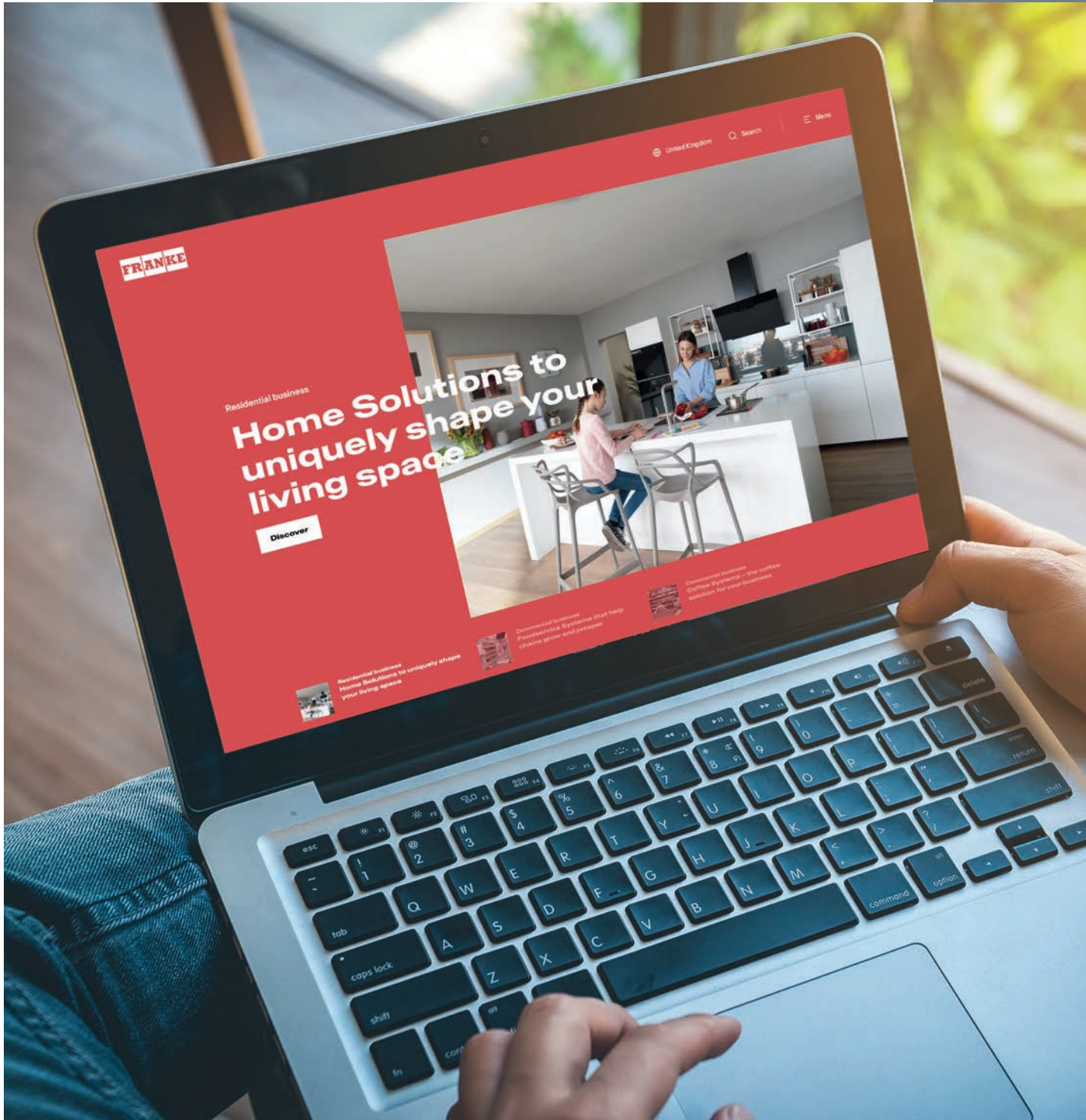

**FRANKE**



**HOME  
SOLUTIONS**

# Complete Solutions for Your Kitchen

Our kitchens are places to be lived in: where we cook, eat, and spend time with family and friends.

Our individual products come together in functional systems designed to make your life easier and to delight your senses, thanks to perfectly coordinated colors and designs in total harmony.

When everything is in balance, it's easier to enjoy every moment.

## Food Preparation Area

### Taps, Sinks, and Waste Sorting Systems

Award-winning and eco-friendly taps perfectly complement elegant and spacious sinks, which can be equipped with accessories to keep everything you need always within reach.

All components are made from durable and hygienic materials, such as stainless steel or our exclusive Fraganite.



## Appliances

### Cooktops, Ovens, and Dishwashers

When we design our appliances, we do so with your everyday habits in mind — to offer functional and easy-to-use solutions that are both smart and visually appealing.

# Inspir

There is no place like home. And there are no two homes alike. The way we cherish our own nest is just as unique as we are, each one with different tastes, preferences, and needs. To help you get inspired and create the kitchen environment of your dreams, and enjoy it every day, we developed three different **families** of products.

## Mythos

### A passion for the best

Our most premium range. technology meets design, while even the smallest details are carefully sought-after. This family sets its goal to the highest levels, combining the very essence of functionality with that of beauty.

## Maris

### Family in the kitchen

A family inspired by families. Cosy and functional, for savouring the heartwarming experience of a family get-together. Maris' philosophy is simple: welcome anyone, anytime with the pride and joy of a homemade dinner.

## Smart

### Straight to what Matters

The simplest things work the best. Essential in its perfection, to jump to what matters the most: bringing joy to your kitchen. A family created to fulfill any need and preference.

What will your kitchen look like it's up to you,  
but whatever your way of bringing joy home, **you can count on us.**

# ations







Tap: Active Twist - TA7711 (2266987)

# Mythos



Sink: Brookmore - BKX 210/110-74 (42994)



Tap: Active Twist - TA7711MB (2266988)



Sink: Bow – BXX 220-36/36 (2008351)

# Maris



Sink: City – MRG110-51MB (2414006)



Sink: City – MRG110-75MB (2414012)









**Sink:** Rapid – RPX 611-86 LHD (2008352)

# Smart



**Sink:** Rapid – RPX 621 LHD (2008356)

# Show what you're made of!

Stainless Steel



## Stainless Steel

Whether you prefer the more reflective qualities of the polished finish or the more subtle look of the silk or brushed finishes, which give a more matt sheen, there is a Stainless Steel solution for you.

Any Franke Stainless Steel product is made from premium quality chrome nickel steel, which looks stunning and is highly resistant to staining, rust and corrosion - plus it won't chip, craze, flake, or break. If Stainless Steel is one of the most popular materials in the kitchen, it's for good reason.



Anthracite



Gold



Copper



## F-Inox Technology

An exclusive Franke coating able to group water molecules and allowing you to dry your sink without ring stains. Water repellent and scratch-resistant, this futuristic coating also fears no heat up to 100°.

A real and long-lasting beauty formula that you can appreciate from our Masterpiece family.



Shiny or matte; smooth or stone-like, extra-strong or super trendy. Your kitchen can speak volumes about you, so every detail counts. To offer you the chance to create your very own perfect kitchen, our range of materials is designed to please any taste, match any style and resist any endeavour. Discover each material's precision-engineered character and unique benefits to choose the one that suits your needs the best and you like the most.

- Matte Black
- Onyx
- Stone Grey
- Polar White

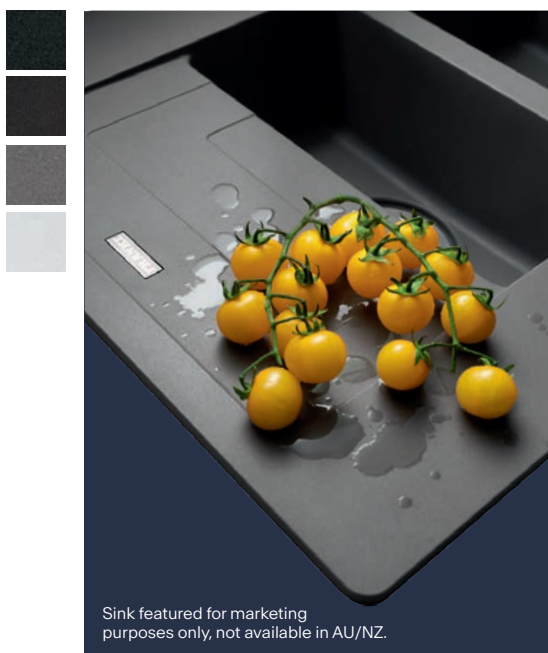

Sink featured for marketing purposes only, not available in AU/NZ.

## Fragranite

An exceptionally tough material, highly resistant to burns, dents, chips and stains.

Pioneered by Franke, it's a unique material with a subtle sheen that is warm to the touch thanks to its close to 80% of quartz sand. The surface is finely textured ensuring high hygiene standards.



## PVD Coating

PVD, standing for Physical Vapor Deposition, is a coating technology that makes Stainless Steel tapware even more resistant to abrasions, scratches and corrosion and offers exceptional aesthetic features as well. A tap treated with a PVD coating even resists UV rays and makes fingerprints less visible in a busy kitchen. There are now an array of other stunning finishes to choose from: Black Steel, Anthracite, Copper and Gold, you really can find something to suit every style of kitchen.



- Black Steel
- Anthracite
- Gold
- Copper

# Sink & Bowl

**Installation:**

**A variety of edge profiles**



Franke offers a variety of ways to install sinks and bowls into benchtops. Depending on the installation method and edge finish chosen, the overall look of the kitchen can vary – from modern and practical to refined and minimalist, elegant or classic.



**TM**

### Topmount – The classic solution

In this classic installation style, the sink features a raised edge around the rim. This design provides additional stability and strength.

The sink is secured in the benchtop cut-out using clips and can be installed into benchtops made from virtually any material.

This installation style suits kitchens designed in a classic aesthetic.

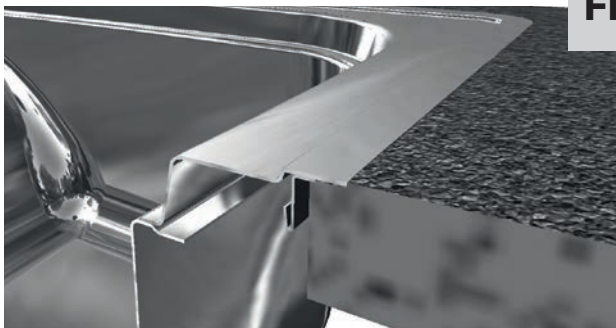

**FM**

### Flushmount – Refined Minimalism

The bowl is installed flush with the benchtop in a precisely machined cut-out.

It is secured using clips and a silicone seal. A flushmount installation is possible with most kitchen benchtop materials.

The seamless transition between benchtop and bowl creates a clean, even surface, making this installation style ideal for premium, minimalist kitchen designs.

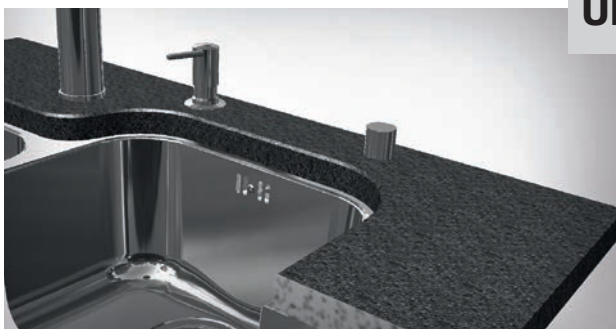

**UM**

### Undermount – The elegant solution

The bowl is mounted from underneath the cut-out in the benchtop, secured with screws and adhesive.

Undermount installation is suitable for solid benchtop materials such as stone or composite, but not for laminated surfaces.

The bowl can be installed either flush with the cut-out or slightly set forward to allow the use of accessories.

An undermount bowl pairs with elegantly designed kitchens.

Suitable Materials: Stainless Steel and Fraganite





# It's always been in our heritage to meet your **needs.**

## **Beautiful and made for real-life use. Steel represents our kitchen ideal.**

The sheer quality of Franke products can be seen and felt. We use AISI 304 18/10 steel, which is produced in Italy and Europe: a choice that reflects our dedication to quality, one of our core priorities over the 100-plus years of our history.

Strong and robust, it maintains its brilliance over time, making it the defining feature of the living spaces in which it is installed.

Its superb technical features ensure that it is always in demand, and highly appreciated by professionals in the haute cuisine sector: furthermore, stainless steel is an extremely hygienic material, and is easy to clean and recyclable. Aesthetically pleasing and functional to use: stainless steel really represents quality in shining armour.

## **Guaranteed peace of mind**

We're so confident in the quality of our products, that every Franke sink is guaranteed for 50 years\*.

In addition, all our sinks are fully compliant with BS EN 13310 and all our manufacturing processes are ISO9001 certified.

Enjoy peace of mind with our kitchen mixers, backed by a 5 year parts and labour warranty and 15 years on the cartridge.

## **Customer Service and Technical Support**







To raise a service request with Franke sinks, taps, or appliances, please contact our Customer Care team.



**Franke Customer Service**  
HS-CustomerCare.AU@franke.com

**(03) 9700 9100**





**For more information and details on warranty conditions:**  
[www.franke.com](http://www.franke.com)

# AVAILABLE ACCESSORIES

	 <b>240057</b> RM44 Rollamat	 <b>2414029</b> RM41 Rollamat	 <b>43000</b> RM55 Rollamat	 <b>2029793</b> DT651 Extension Drainer	 <b>2401329</b> DT360 Extension Drainer	 <b>2400491</b> DB448 Drainer Basket	 <b>2401361</b> CB931 Chopping Board
<b>ANX 110-34</b> (2400799)	•			•		•	
<b>ANX 110-48</b> (2400800)	•			•		•	
<b>ANX 120</b> (2029811)	•			•		•	
<b>BWX 220-41/27</b> (2406002)					•		
<b>BWX 120-41/27</b> (2406001)					•		
<b>BKX 210/110-36</b> (42992)			•		•		
<b>BKX 210/110-59</b> (42993)			•		•		
<b>BKX 210/110-74</b> (42994)			•		•		
<b>BKX 220/120-36-36</b> (42995)			•		•		
<b>BKX 210-36 TL</b> (42996)			•		•		
<b>BKX 210-59 TL</b> (42997)			•		•		
<b>BKX 210-74 TL</b> (42998)			•		•		
<b>BKX 220-36-36 TL</b> (42999)			•		•		
<b>BXX 210-36</b> (2008348)	•				•	•	•
<b>BXX 210-50</b> (2008350)	•				•	•	•
<b>BXX 210-68</b> (2008349)	•				•	•	•
<b>BXX 220-36/36</b> (2008351)	•				•	•	•
<b>BXX 220-42/29 SBL</b> (2008459)	•				•	•	•
<b>BXX 220-42/29 SBR</b> (2008460)	•				•	•	•
<b>RPX 611-86 LHD</b> (2008352)							
<b>RPX 611-86 RHD</b> (2008353)							
<b>RPX 651 LHD</b> (2008354)							
<b>RPX 651 RHD</b> (2008355)							
<b>RPX 621 LHD</b> (2008356)							
<b>RPX 621 RHD</b> (2008357)							
<b>UCG 611-100</b> (Refer to page 65 for model codes)							
<b>UCG 620-78</b> (2406928), (2406930), (2406929)	•				•	•	
<b>UCG 621</b> (Refer to page 65 for model codes)							
<b>MRG110-39</b> (2414000), (2414001), (2414002)		•					
<b>MRG610-51FTL</b> (2414003), (2414004), (2414005)		•			•		
<b>MRG110-51</b> (2414006), (2414007), (2414008)		•			•		
<b>MRG610-75FTL</b> (2414009), (2414010), (2414011)		•			•		
<b>MRG110-75</b> (2414012), (2414013), (2414014)		•			•		
<b>MRG620-36/36FTL</b> (2414015), (2414016), (2414017)		•			•		
<b>MRG120-36/36</b> (2414018), (2414019), (2414020)		•			•		
<b>MRG620-43/30FTL</b> (2414021), (2414022), (2414023)		•			•		
<b>MRG120-43/30</b> (2414024), (2414025), (2414026)		•			•		

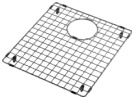
	 <b>2414027</b> CB104 Chopping Board	 <b>43001</b> CB050 Chopping Board	 <b>2400570</b> SB060 Strainer Bowl	 <b>2414028</b> SB103 Strainer Bowl	 <b>2403079</b> All-In	 <b>43003</b> Brookmore Accessory Pack
<b>ANX 110-34</b> (2400799)					•	
<b>ANX 110-48</b> (2400800)					•	
<b>ANX 120</b> (2029811)					•	
<b>BWX 220-41/27</b> (2406002)					•	
<b>BWX 120-41/27</b> (2406001)					•	
<b>BKX 210/110-36</b> (42992)		•	•			•
<b>BKX 210/110-59</b> (42993)		•	•			•
<b>BKX 210/110-74</b> (42994)		•	•			•
<b>BKX 220/120-36-36</b> (42995)		•	•			•
<b>BKX 210-36 TL</b> (42996)		•	•			•
<b>BKX 210-59 TL</b> (42997)		•	•			•
<b>BKX 210-74 TL</b> (42998)		•	•			•
<b>BKX 220-36-36 TL</b> (42999)		•	•			•
<b>BXX 210-36</b> (2008348)					•	
<b>BXX 210-50</b> (2008350)					•	
<b>BXX 210-68</b> (2008349)					•	
<b>BXX 220-36/36</b> (2008351)					•	
<b>BXX 220-42/29 SBL</b> (2008459)					•	
<b>BXX 220-42/29 SBR</b> (2008460)					•	
<b>RPX 611-86 LHD</b> (2008352)					•	
<b>RPX 611-86 RHD</b> (2008353)					•	
<b>RPX 651 LHD</b> (2008354)					•	
<b>RPX 651 RHD</b> (2008355)					•	
<b>RPX 621 LHD</b> (2008356)					•	
<b>RPX 621 RHD</b> (2008357)					•	
<b>UCG 611-100</b> (Refer to page 65 for model codes)					•	
<b>UCG 620-78</b> (2406928), (2406930), (2406929)					•	
<b>UCG 621</b> (Refer to page 65 for model codes)					•	
<b>MRG110-39</b> (2414000), (2414001), (2414002)					•	
<b>MRG610-51FTL</b> (2414003), (2414004), (2414005)	•			•	•	
<b>MRG110-51</b> (2414006), (2414007), (2414008)	•			•	•	
<b>MRG610-75FTL</b> (2414009), (2414010), (2414011)	•			•	•	
<b>MRG110-75</b> (2414012), (2414013), (2414014)	•			•	•	
<b>MRG620-36/36FTL</b> (2414015), (2414016), (2414017)	•			•	•	
<b>MRG120-36/36</b> (2414018), (2414019), (2414020)	•			•	•	
<b>MRG620-43/30FTL</b> (2414021), (2414022), (2414023)	•			•	•	
<b>MRG120-43/30</b> (2414024), (2414025), (2414026)	•			•	•	

# CITY SINK BOTTOM GRID COMPATIBILITY

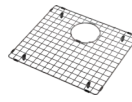
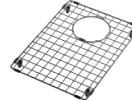
	 <b>2406932</b> BG347	 <b>2406933</b> BG322	 <b>2404003</b> BG442	 <b>2406934</b> BG710	 <b>2406935</b> BG390	 <b>2406936</b> BG264
<b>MRG110-39</b> (2414000) (2414001) (2414002)						
<b>MRG610-51FTL</b> (2414003) (2414004) (2414005)			•			
<b>MRG110-51</b> (2414006) (2414007) (2414008)			•			
<b>MRG610-75FTL</b> (2414009) (2414010) (2414011)				•		
<b>MRG110-75</b> (2414012) (2414013) (2414014)				•		
<b>MRG620-36/36FTL</b> (2414015) (2414016) (2414017)		•				
<b>MRG120-36/36</b> (2414018) (2414019) (2414020)		•				
<b>MRG620-43/30FTL</b> (2414021) (2414022) (2414023)					•	•
<b>MRG120-43/30</b> (2414024) (2414025) (2414026)					•	•



# Sinks





Bow Centre 40  
Brookmore 42  
Ancona 50  
Bow 54  
City 60  
Rapid 72



# SINKS OVERVIEW

MYTHOS

**BOW CENTRE** BWX 220-41/27  
(2406002) 127.0645.024



TM/FM | 790 x 510mm

**BOW CENTRE** BWX 120-41/27  
(2406001) 122.0644.826



UM | 820 x 520mm

**BROOKMORE** BKX 210/110-36  
(42992) 127.0761.643



TM/UM | 395 x 460mm

**BROOKMORE** BKX 210/110-59  
(42993) 127.0761.644



TM/UM | 625 x 460mm

**BROOKMORE** BKX 210-74 TL  
(42998) 127.0761.649



TM/FM | 785 x 530mm

**BROOKMORE** BKX 220-36-36 TL  
(42999) 127.0761.650



TM/FM | 785 x 530mm

MARIS

**ANCONA** ANX 110-34 (2400799)  
122.0426.105



UM | 370 x 430mm

**ANCONA** ANX 110-48 (2400800)  
122.0426.106



UM | 510 x 430mm

**ANCONA** ANX 120 (2029811)  
122.0644.823



UM | 770 x 450mm

**BOW** BXX 210-36 (2008348)  
127.0678.817



TM/UM/FM | 400 x 450mm

**BOW** BXX 220-42/29 SBR (2008460)  
127.0678.799



TM/UM/FM | 780 x 450mm

**CITY** UCG 611-100MB RHD (13474)  
114.0755.705



TM | 1000 x 500mm

**CITY** UCG 611-100MB LHD (13473)  
114.0755.702



TM | 1000 x 500mm

**CITY** UCG 611-100ON RHD (12413)  
114.0755.706



TM | 1000 x 500mm

**CITY** UCG 621MB LHD (13769)  
114.0756.133



TM | 1160 x 500mm

**CITY** UCG 621ON RHD (13476)  
114.0756.137



TM | 1160 x 500mm

**CITY** UCG 621ON LHD (13475)  
114.0756.134



TM | 1160 x 500mm

**CITY** UCG 621PW RHD (13768)  
114.0756.138



TM | 1160 x 500mm

**CITY** MRG610-51FTLMB (2414003)  
114.0724.195



TM | 549 x 530mm

**CITY** MRG610-51FTLON (2414004)  
114.0724.193



TM | 549 x 530mm

**CITY** MRG610-51FTLPW (2414005)  
114.0724.194



TM | 549 x 530mm

**CITY** MRG110-51MB (2414006)  
125.0724.208



UM | 549 x 453mm

**CITY** MRG610-75FTLPW (2414011)  
114.0724.176



TM | 787 x 530mm

**CITY** MRG110-75MB (2414012)  
125.0724.196



UM | 788 x 453mm

**CITY** MRG110-75ON (2414013)  
125.0724.197



UM | 788 x 453mm

**CITY** MRG110-75PW (2414014)  
125.0724.198



UM | 788 x 453mm

**LEGEND**

**TM** = Topmount **UM** = Undermount **FM** = Flushmount

**BROOKMORE** BKX 210/110-74  
(42994) 127.0761.645



**TM/UM** | 775 x 460mm

**BROOKMORE** BKX 220/120-36-36  
(42995) 127.0761.646



**TM/UM** | 775 x 460mm

**BROOKMORE** BKX 210-36 TL  
(42996) 127.0761.647



**TM/FM** | 405 x 530mm

**BROOKMORE** BKX 210-59 TL  
(42997) 127.0761.648



**TM/FM** | 635 x 530mm

**BOW** BXX 210-50 (2008350)  
127.0677.188



**TM/UM/FM** | 540 x 450mm

**BOW** BXX 210-68 (2008349)  
127.0677.198



**TM/UM/FM** | 720 x 450mm

**BOW** BXX 220-36/36 (2008351)  
127.0678.730



**TM/UM/FM** | 782 x 450mm

**BOW** BXX 220-42/29 SBL (2008459)  
127.0678.811



**TM/UM/FM** | 780 x 450mm

**CITY** UCG 611-100ON LHD (12392)  
114.0755.703



**TM** | 1000 x 500mm

**CITY** UCG 611-100PW RHD (13472)  
114.0755.707



**TM** | 1000 x 500mm

**CITY** UCG 611-100PW LHD (13471)  
114.0755.704



**TM** | 1000 x 500mm

**CITY** UCG 621MB RHD (13770)  
114.0756.136



**TM** | 1160 x 500mm

**CITY** UCG 621PW LHD (13767)  
114.0756.135



**TM** | 1160 x 500mm

**CITY** MRG110-39MB (2414000)  
125.0724.205



**UM** | 440 x 448mm

**CITY** MRG110-39ON (2414001)  
125.0724.206



**UM** | 440 x 448mm

**CITY** MRG110-39PW (2414002)  
125.0724.207



**UM** | 440 x 448mm

**CITY** MRG110-51ON (2414007)  
125.0724.209



**UM** | 549 x 453mm

**CITY** MRG110-51PW (2414008)  
125.0724.210



**UM** | 549 x 453mm

**CITY** MRG610-75FTLMB (2414009)  
114.0724.174



**TM** | 787 x 530mm

**CITY** MRG610-75FTLON (2414010)  
114.0724.175



**TM** | 787 x 530mm

**CITY** MRG620-36/36FTLMB  
(2414015) 114.0724.177



**TM** | 787 x 530mm

**CITY** MRG620-36/36FTLON  
(2414016) 114.0724.178



**TM** | 787 x 530mm

**CITY** MRG620-36/36FTLPW  
(2414017) 114.0724.179



**TM** | 787 x 530mm

**CITY** MRG120-36/36MB (2414018)  
125.0724.199



**UM** | 788 x 453mm

# SINKS OVERVIEW

MARIS

**CITY MRG120-36/36ON (2414019)**  
125.0724.200



**UM** | 788 x 453mm

**CITY MRG120-36/36PW (2414020)**  
125.0724.201



**UM** | 788 x 453mm

**CITY MRG620-43/30FTLMB (2414021)** 114.0724.180



**TM** | 787 x 530mm

**CITY MRG620-43/30FTLON (2414022)** 114.0724.191



**TM** | 787 x 530mm

**CITY MRG620-43/30FTLPW (2414023)** 114.0724.192



**TM** | 787 x 530mm

**CITY MRG120-43/30MB (2414024)**  
125.0724.202



**UM** | 788 x 453mm

**CITY MRG120-43/30ON (2414025)**  
125.0724.203



**UM** | 788 x 453mm

**CITY MRG120-43/30PW (2414026)**  
125.0724.204



**UM** | 788 x 453mm

SMART

**RAPID RPX 611-86 LHD (2008352)**  
101.0644.696



**TM** | 860 x 500mm

**RAPID RPX 611-86 RHD (2008353)**  
101.0644.695



**TM** | 860 x 500mm

**RAPID RPX 651 LHD (2008354)**  
101.0644.699



**TM** | 1000 x 500mm

**RAPID RPX 651 RHD (2008355)**  
101.0644.697



**TM** | 1000 x 500mm

**RAPID RPX 621 LHD (2008356)**  
101.0644.704



**TM** | 1160 x 500mm

**RAPID RPX 621 RHD (2008357)**  
101.0644.702



**TM** | 1160 x 500mm

**LEGEND**

**TM** = Topmount    **UM** = Undermount    **FM** = Flushmount



# Bow Centre

Topmount/Flushmount/Undermount



## Included Accessories

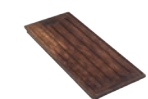

01

**2407081**  
Chopping Board

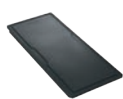

02

**2407082**  
Chopping Board



03

**2407083**  
Wire Rack



04

**2407084**  
Knife Set



05

**2407085**  
Knife Holder



06

**2407086**  
Strainer Bowl



07

**2407087**  
Stainless  
Organiser



08

**2407088**  
Remote Waste  
Push Button

## Available Accessories



09

**2401329**  
Extension  
Drainer

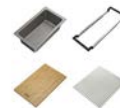

10

**2403079**  
All-In  
Accessory Pack

MYTHOS

- 01 02
- 03 04
- 05 06
- 07 08



Dimension **790 x 510 mm**

Bowl 1 Size **410 x 480 x 200mm**  
 Bowl 2 Size **270 x 480 x 200mm**

Bowl Radius **12mm**

Cut-out Size **Template**

Overflow **Yes**

Configuration **Reversible**

**BWX 220-41/27**  
(2406002)

Stainless Steel  
127.0645.024

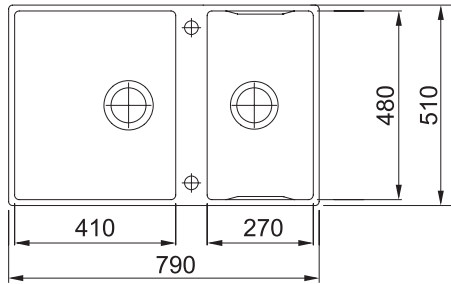

Topmount Flushmount AISI 304

MYTHOS

- 01 02
- 03 04
- 05 06
- 07 08
- 09 10



Dimension **820 x 520 mm**

Bowl 1 Size **410 x 480 x 200mm**  
 Bowl 2 Size **270 x 480 x 200mm**

Bowl Radius **12mm**

Cut-out Size **Template**

Overflow **Yes**

Configuration **Reversible**

**BWX 120-41/27**  
(2406001)

Stainless Steel  
122.0644.826

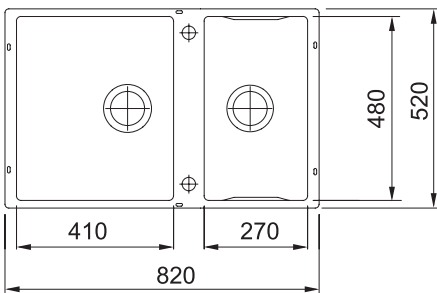

Undermount AISI 304

**LEGEND** Topmount Flushmount Undermount

# Brookmore

## Topmount/Undermount



### Available Accessories

- 01** **43000**  
Rollamat
- 02** **2400570**  
Strainer  
Bowl
- 03** **2401329**  
Extension  
Drainer
- 04** **43001**  
Chopping  
Board

### Available Accessory Packs

- 05** **43003**  
Brookmore  
Accessory Pack

#### LEGEND



= Topmount



= Flushmount



= Undermount

MYTHOS



- 01 02
- 03 04
- 05



Dimension **395 x 460mm**

Bowl Size **355 x 420mm**

Bowl Radius **20mm**

Cut-out Size **Template**

Overflow **Yes**

**BKX 210/110-36**  
(42992)

 **Stainless Steel**  
127.0761.643

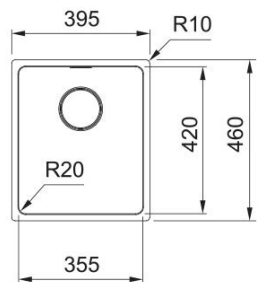

  **AISI 304**

MYTHOS



- 01 02
- 03 04
- 05



Dimension **625 x 460mm**

Bowl Size **585 x 420mm**

Bowl Radius **20mm**

Cut-out Size **Template**

Overflow **Yes**

**BKX 210/110-59**  
(42993)

 **Stainless Steel**  
127.0761.644

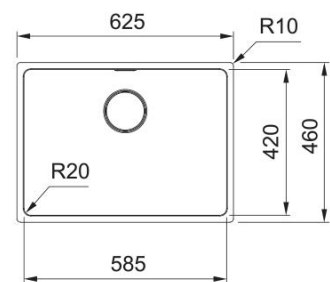

  **AISI 304**

# Brookmore

## Topmount/Undermount



### Available Accessories



01  
**43000**  
Rollamat

02  
**2400570**  
Strainer  
Bowl

03  
**2401329**  
Extension  
Drainer

04  
**43001**  
Chopping  
Board

### Available Accessory Packs

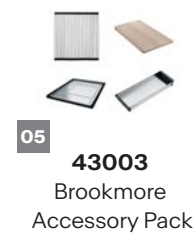

05  
**43003**  
Brookmore  
Accessory Pack

#### LEGEND



= Topmount



= Flushmount



= Undermount

MYTHOS



- 01 02
- 03 04
- 05

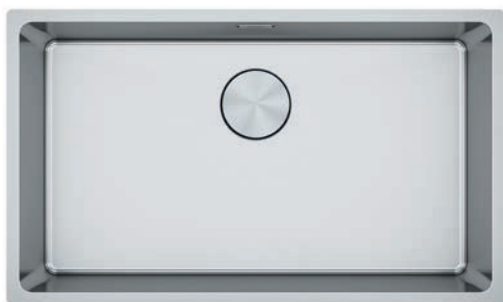

Dimension **775 x 460mm**

Bowl Size **735 x 420mm**

Bowl Radius **20mm**

Cut-out Size **Template**

Overflow **Yes**

**BKX 210/110-74**  
(42994)

Stainless Steel  
127.0761.645

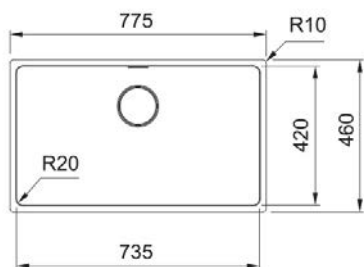

AISI 304

MYTHOS



- 01 02
- 03 04
- 05



Dimension **775 x 460mm**

Bowl Size **x2 (355 x 420mm)**

Bowl Radius **20mm**

Cut-out Size **Template**

Overflow **Yes**

**BKX 220/120-36-36**  
(42995)

Stainless Steel  
127.0761.646

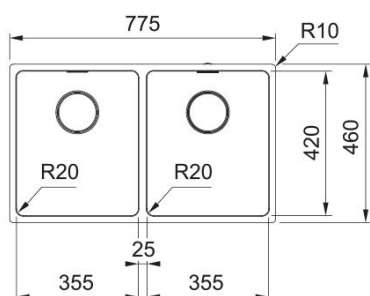

AISI 304

# Brookmore

## Topmount/Flushmount



### Available Accessories



**01**  
**43000**  
Rollamat



**02**  
**2400570**  
Strainer  
Bowl



**03**  
**2401329**  
Extension  
Drainer



**04**  
**43001**  
Chopping  
Board

### Available Accessory Packs



**05**  
**43003**  
Brookmore  
Accessory Pack

#### LEGEND

 = Topmount

 = Flushmount

 = Undermount

MYTHOS



- 01 02
- 03 04
- 05

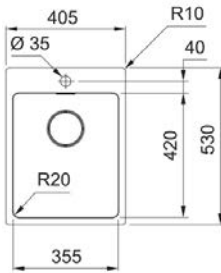

▨ ▨ AISI 304

Dimension **405 x 530mm**

Bowl Size **355 x 420mm**

Bowl Radius **20mm**

Cut-out Size **Template**

Overflow **Yes**

**BKX 210-36 TL**  
(42996)

▨ Stainless Steel  
127.0761.647

MYTHOS



- 01 02
- 03 04
- 05

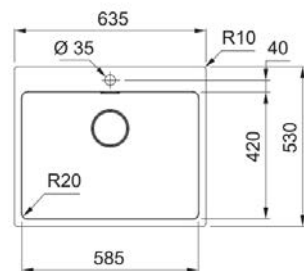

▨ ▨ AISI 304

Dimension **635 x 530mm**

Bowl Size **585 x 420mm**

Bowl Radius **20mm**

Cut-out Size **Template**

Overflow **Yes**

**BKX 210-59 TL**  
(42997)

▨ Stainless Steel  
127.0761.648

# Brookmore

## Topmount/Flushmount





Model Pictured is BKX 210/110-74

### Available Accessories

-   
**01**  
**43000**  
 Rollamat
-   
**02**  
**2400570**  
 Strainer  
 Bowl
-   
**03**  
**2401329**  
 Extension  
 Drainer
-   
**04**  
**43001**  
 Chopping  
 Board

### Available Accessory Packs

-   
**05**  
**43003**  
 Brookmore  
 Accessory Pack

**LEGEND**  = Topmount  = Flushmount  = Undermount

MYTHOS

- 01 02
- 03 04
- 05



Dimension **785 x 530mm**

Bowl Size **735 x 420mm**

Bowl Radius **20mm**

Cut-out Size **Template**

Overflow **Yes**

**BKX 210-74 TL**  
(42998)

 **Stainless Steel**  
127.0761.649

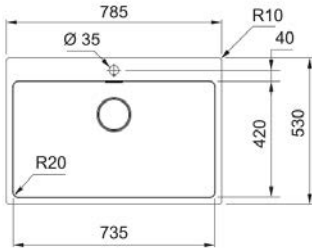

  **AISI 304**

MYTHOS

- 01 02
- 03 04
- 05



Dimension **785 x 530mm**

Bowl Size **x2 (355 x 420mm)**

Bowl Radius **20mm**

Cut-out Size **Template**

Overflow **Yes**

**BKX 220-36-36 TL**  
(42999)

 **Stainless Steel**  
127.0761.650

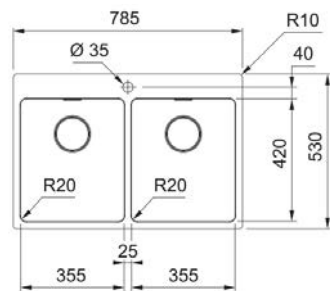

  **AISI 304**

# Ancona

## Undermount



### Available Accessories



**01**  
**2029793**  
Extension  
Drainer



**02**  
**2400572**  
Rollamat



**03**  
**2400491**  
Drainer  
Basket

### Available Accessory Packs

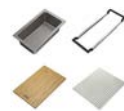

**04**  
**2403079**  
All-In  
Accessory Pack

#### LEGEND



= Topmount



= Flushmount



= Undermount

MARIS

01 02  
03 04

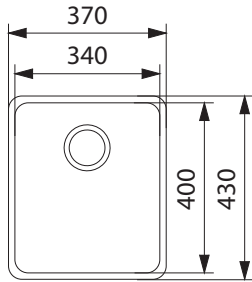

 AISI 304

Dimension **370 x 430mm**

Bowl Size **340 x 400 x 190mm**

Bowl Radius **36mm**

Cut-out Size **Template**

Overflow **Yes**

**ANX 110-34**  
(2400799)

 **Stainless Steel**  
122.0426.105

MARIS

01 02  
03 04

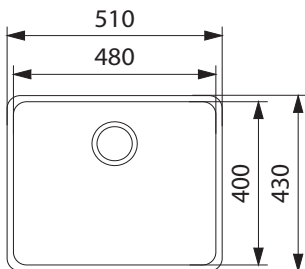
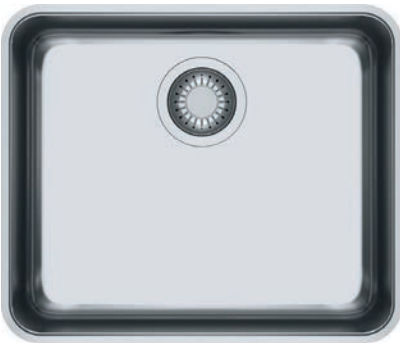

 AISI 304

Dimension **820 x 520 mm**

Bowl 1 Size **410 x 480 x 200mm**

Bowl 2 Size **270 x 480 x 200mm**

Bowl Radius **12mm**

Cut-out Size **Template**

Overflow **Yes**

**ANX 110-48**  
(2400800)

 **Stainless Steel**  
122.0426.106



# Ancona

## Undermount



Model Pictured is ANX110-34

### Available Accessories

-   
**01** **2029793**  
Extension  
Drainer
-   
**02** **2400572**  
Rollamat
-   
**03** **2400491**  
Drainer  
Basket

### Available Accessory Packs

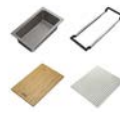
-   
**04** **2403079**  
All-In  
Accessory Pack

#### LEGEND



= Topmount



= Flushmount



= Undermount

MARIS

01 02  
03 04



Dimension **770 x 450 mm**

Bowl 1 Size **340 x 400 x 190mm**

Bowl 2 Size **340 x 400 x 190mm**

Bowl Radius **36mm**

Cut-out Size **Template**

Overflow **Yes**

**ANX 120**  
(2029811)

Stainless Steel  
122.0644.823

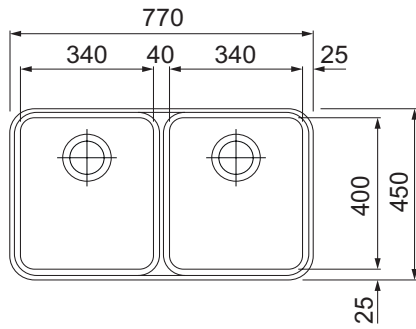





 AISI  
304

# Bow

## Topmount/Flushmount/Undermount



### Available Accessories

-   
**01** **2401329**  
Extension Drainer
-   
**02** **2401361**  
Chopping Board
-   
**03** **2400572**  
Rollamat
-   
**04** **2400491**  
Drainer Basket

### Available Accessory Packs

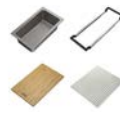
-   
**05** **2403079**  
All-In Accessory Pack

**LEGEND**  = Topmount  = Flushmount  = Undermount

MARIS

- 01 02
- 03 04
- 05

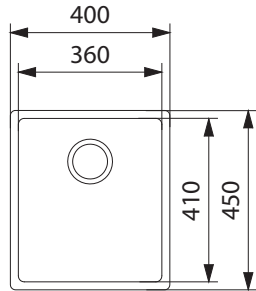

AISI 304

Dimension **400 x 450mm**

Bowl Size **360 x 410 x 200mm**

Bowl Radius **12mm**

Cut-out Size **Template**

Overflow **No**

**BXX 210-36**  
(2008348)

Stainless Steel  
 127.0678.817

MARIS

- 01 02
- 03 04
- 05

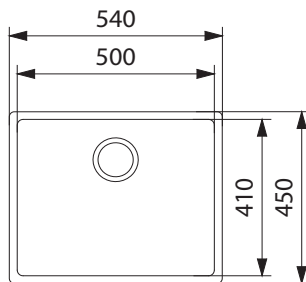

AISI 304

Dimension **540 x 450mm**

Bowl Size **500 x 410 x 200mm**

Bowl Radius **12mm**

Cut-out Size **Template**

Overflow **No**

**BXX 210-50**  
(2008350)





Stainless Steel  
 127.0677.188

# Bow

Topmount/Flushmount/Undermount



## Available Accessories

-   
**01** **2401329**  
Extension  
Drainer
-   
**02** **2401361**  
Chopping Board
-   
**03** **2400572**  
Rollamat
-   
**04** **2400491**  
Drainer  
Basket

## Available Accessory Packs

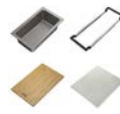
-   
**05** **2403079**  
All-In  
Accessory Pack

### LEGEND



= Topmount



= Flushmount



= Undermount

MARIS

- 01 02
- 03 04
- 05



Dimension **720 x 450mm**  
 Bowl Size **680 x 410 x 200mm**  
 Bowl Radius **12mm**  
 Cut-out Size **Template**  
 Overflow **No**

**BXX 210-68**  
(2008349)

Stainless Steel  
127.0677.198

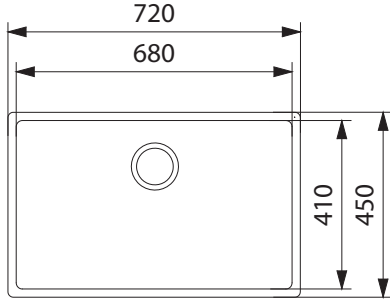

▨ ▨ ▨ AISI 304

MARIS

- 01 02
- 03 04
- 05



Dimension **782 x 450mm**  
 Bowl 1 Size **360 x 410 x 200mm**  
 Bowl 2 Size **360 x 410 x 200mm**  
 Bowl Radius **12mm**  
 Cut-out Size **Template**  
 Overflow **No**

**BXX 220-36/36**  
(2008351)

Stainless Steel  
127.0678.730

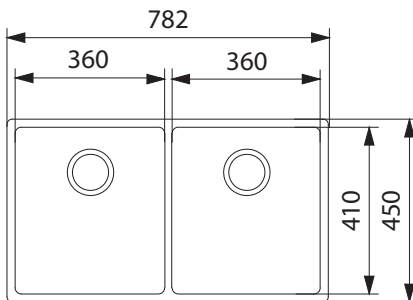

▨ ▨ ▨ AISI 304





# Bow

## Topmount/Flushmount/Undermount







Model Pictured is BXX220-36/36

### Available Accessories

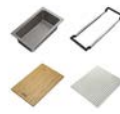
-   
**01** **2401329**  
Extension  
Drainer
-   
**02** **2401361**  
Chopping Board
-   
**03** **2400572**  
Rollamat
-   
**04** **2400491**  
Drainer  
Basket

### Available Accessory Packs

-   
**05** **2403079**  
All-In  
Accessory Pack

**LEGEND**  = Topmount  = Flushmount  = Undermount

MARIS

- 01 02
- 03 04
- 05



Dimension **780 x 450mm**

Bowl 1 Size **420 x 410 x 200mm**  
Bowl 2 Size **298 x 410 x 200mm**

Bowl Radius **12mm**

Cut-out Size **Template**

Overflow **No**

**BXX 220-42/29**

Stainless Steel  
SBL: 127.0678.811  
(2008459)  
SBR: 127.0678.799  
(2008460)

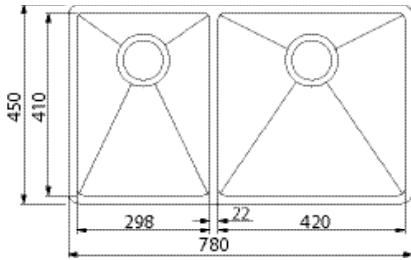

**Small Bowl Left (SBL) Model Shown**

Available in Small Bowl Right (SBR) configuration.

 AISI 304

# City

## Topmount



### Available Accessory Packs

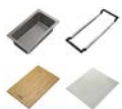

01

**2403079**

All-In

Accessory Pack

**LEGEND**



= Topmount



= Flushmount



= Undermount

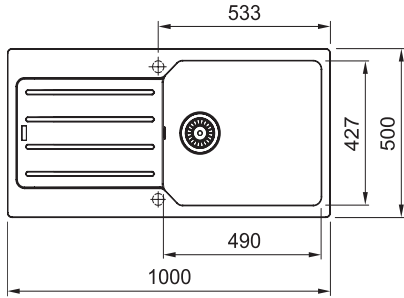

Dimension **1000 x 500mm**

Bowl Size **490 x 427 x 190mm**

Bowl Radius **25mm**

Cut-out Size **964 x 464mm**

Corner Radius **15**

Overflow **Yes**

**Left Hand Drainer (LHD) Model Shown**  
Available in Right Hand Drainer (RHD) configuration.

**UCG 611-100**

- Matte Black**  
LHD: 114.0755.705 (13474)  
RHD: 114.0755.702 (13473)
- Onyx**  
LHD: 114.0755.706 (12413)  
RHD: 114.0755.703 (12392)
- Polar White**  
LHD: 114.0755.707 (13472)  
RHD: 114.0755.704 (13471)

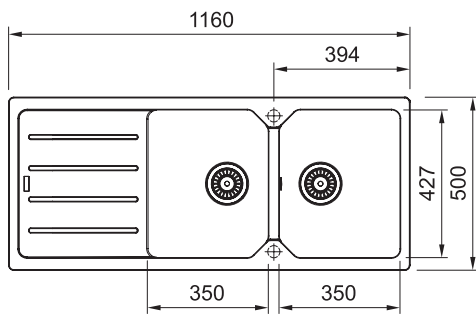

Dimension **1160 x 500mm**

Bowl 1 Size **350 x 427 x 190mm**  
Bowl 2 Size **350 x 427 x 190mm**

Bowl Radius **25mm**

Cut-out Size **1124 x 464mm**

Corner Radius **15**

Overflow **Yes**

**Left Hand Drainer (LHD) Model Shown**  
Available in Right Hand Drainer (RHD) configuration.

**UCG 621**

- Matte Black**  
LHD: 114.0756.136 (13770)  
RHD: 114.0756.133 (13769)
- Onyx**  
LHD: 114.0756.137 (13476)  
RHD: 114.0756.134 (13475)
- Polar White**  
LHD: 114.0756.138 (13768)  
RHD: 114.0756.135 (13767)



Stainless steel waste kits and overflows come standard with onyx and polar white sinks.

## Topmount/Undermount



Model Pictured is MRG610-75FTL

### Available Accessories

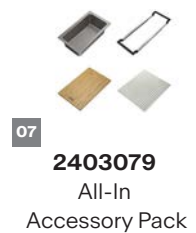
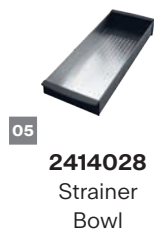
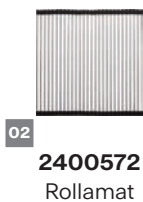

### Available Accessory Packs

#### LEGEND

 = Topmount

 = Flushmount

 = Undermount

MARIS

02 03  
07

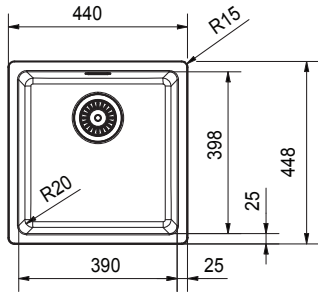

Dimension **440 x 448mm**



Bowl Size **390 x 398 x 200mm**

Bowl Radius **20mm**

Cut-out Size **Refer to manual**

Overflow **Yes**

**MRG 110-39**

-  **Matte Black**  
(2414000)  
125.0724.205
-  **Onyx**  
(2414001)  
125.0724.206
-  **Polar White**  
(2414002)  
125.0724.207

MARIS

01 04  
05 06  
07

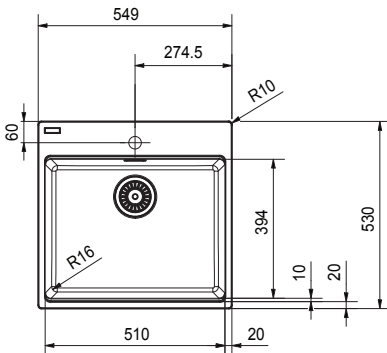

Dimension **549 x 530mm**



Bowl Size **510 x 394 x 240mm**

Bowl Radius **16mm**

Cut-out Size **Refer to manual**

Overflow **Yes**

**MRG610-51FTL**

-  **Matte Black**  
(2414003)  
114.0724.195
-  **Onyx**  
(2414004)  
114.0724.193
-  **Polar White**  
(2414005)  
114.0724.194



Stainless steel waste kits and overflows come standard with onyx and polar white sinks.



### Available Accessories



01

**2414029**  
Rollamat



02

**2414027**  
Chopping  
Board



03

**2414028**  
Strainer  
Bowl



04

**BG322**  
Bottom  
Grid



05

**BG710**  
Bottom  
Grid

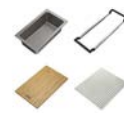

06

**2403079**  
All-In  
Accessory Pack

### Available Accessory Packs

#### LEGEND



= Topmount



= Flushmount



= Undermount

MARIS

- 01 02
- 03 04
- 06



Dimension **549 x 453mm**



Bowl Size **510 x 394 x 240mm**

Bowl Radius **16mm**

Cut-out Size **Refer to manual**

Overflow **Yes**

**MRG110-51**

-  **Matte Black**  
(2414006)  
125.0724.208
-  **Onyx**  
(2414007)  
125.0724.209
-  **Polar White**  
(2414008)  
125.0724.210

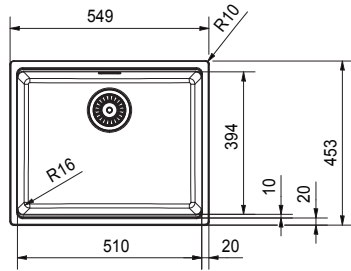

MARIS

- 01 02
- 03 05
- 06



Dimension **787 x 539mm**



Bowl Size **750 x 394 x 240mm**

Bowl Radius **16mm**

Cut-out Size **Refer to manual**

Overflow **Yes**

**MRG610-75FTL**

-  **Matte Black**  
(2414009)  
114.0724.174
-  **Onyx**  
(2414010)  
114.0724.175
-  **Polar White**  
(2414011)  
114.0724.176

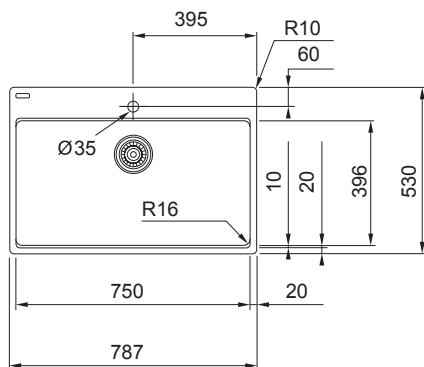

Stainless steel waste kits and overflows come standard with onyx and polar white sinks.

## Topmount/Undermount



### Available Accessories



01

**2414029**  
Rollamat



02

**2414027**  
Chopping  
Board



03

**2414028**  
Strainer  
Bowl



04

**BG322**  
Bottom  
Grid



05

**BG710**  
Bottom  
Grid

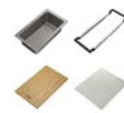

06

**2403079**  
All-In  
Accessory Pack

### Available Accessory Packs

#### LEGEND



= Topmount



= Flushmount



= Undermount

MARIS

- 01 02
- 03 05
- 06



Dimension **788 x 453mm**

Bowl Size **748 x 394 x 240mm**

Bowl Radius **16mm**

Cut-out Size **Refer to manual**

Overflow **Yes**

### MRG110-75

- Matte Black**  
(2414012)  
125.0724.196
- Onyx**  
(2414013)  
125.0724.197
- Polar White**  
(2414014)  
125.0724.198

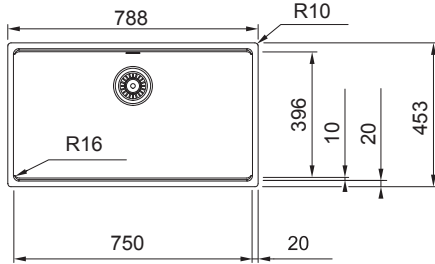

MARIS

- 01 02
- 03 04
- 06



Dimension **787 x 530mm**

Bowl 1 Size **358 x 394 x 240mm**

Bowl 2 Size **358 x 394 x 240mm**

Bowl Radius **16mm**

Cut-out Size **Refer to manual**

Overflow **Yes**

### MRG620-36/36FTL

- Matte Black**  
(2414015)  
114.0724.177
- Onyx**  
(2414016)  
114.0724.178
- Polar White**  
(2414017)  
114.0724.179

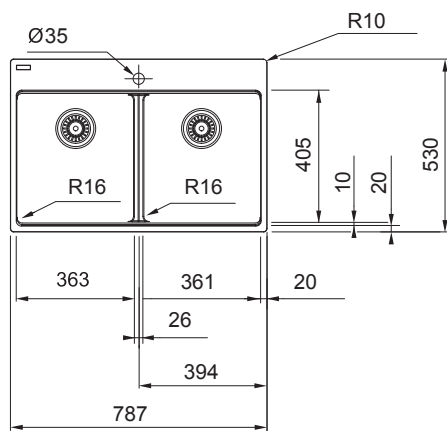

Stainless steel waste kits and overflows come standard with onyx and polar white sinks.



### Available Accessories

-   
**01**  
**2414029**  
 Rollamat
-   
**02**  
**2414027**  
 Chopping Board
-   
**03**  
**2414028**  
 Strainer Bowl
-   
**04**  
**BG322**  
 Bottom Grid

### Available Accessory Packs

-   
**05**  
**2403079**  
 All-In Accessory Pack

**LEGEND**  = Topmount  = Flushmount  = Undermount

MARIS

- 01 02
- 03 04
- 05



Dimension **788 x 453mm**

Bowl 1 Size **358 x 394 x 240mm**  
Bowl 2 Size **358 x 394 x 240mm**

Bowl Radius **16mm**

Cut-out Size **Refer to manual**

Overflow **Yes**

**MRG120-36/36**

-  **Matte Black**  
(2414018)  
125.0724.199
-  **Onyx**  
(2414019)  
125.0724.200
-  **Polar White**  
(2414020)  
125.0724.201

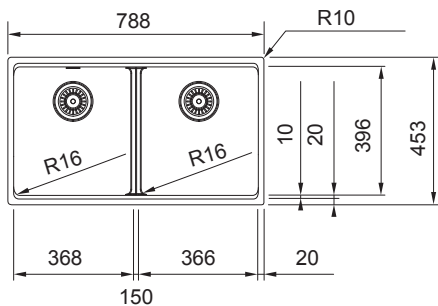

Stainless steel waste kits and overflows come standard with onyx and polar white sinks.

### MAKE YOUR SPACE WORK FOR YOU

It's no secret that your kitchen can get messy in the blink of an eye. But with a low-divide sink you can keep your mess in check.

The double bowl allows you to multi-task with ease, while the low divide creates a larger single bowl perfect for cleaning oversized cookware and bakeware.

City sinks are equipped with deep capacity bowls that can easily fit baking trays, pots and pans to be washed with maximum ease.



#### Available Accessories



01  
**2414029**  
Rollamat



02  
**2414027**  
Chopping Board



03  
**2414028**  
Strainer Bowl

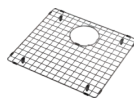

04  
**BG390 & BG264**  
Bottom Grids

#### Available Accessory Packs

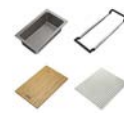

05  
**2403079**  
All-In Accessory Pack

#### LEGEND



= Topmount



= Flushmount



= Undermount

MARIS

- 01 02
- 03 04
- 05



Dimension **787 x 530mm**

Bowl 1 Size **421 x 394 x 240mm**  
Bowl 2 Size **295 x 394 x 240mm**



Bowl Radius **16mm**

Cut-out Size **Refer to manual**

Overflow **Yes**

**Featuring half height divider**

**MRG620-43/30FTL**

-  **Matte Black**  
(2414021)  
114.0724.180
-  **Onyx**  
(2414022)  
114.0724.191
-  **Polar White**  
(2414023)  
114.0724.192

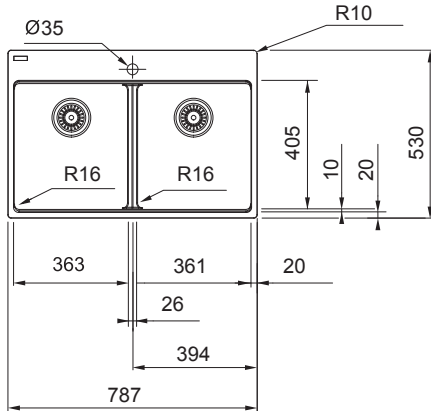

MARIS

- 01 02
- 03 04
- 05



Dimension **788 x 453mm**

Bowl 1 Size **421 x 394 x 240mm**  
Bowl 2 Size **295 x 394 x 240mm**



Bowl Radius **16mm**

Cut-out Size **Refer to manual**

Overflow **Yes**

**Featuring half height divider**

**MRG120-43/30**

-  **Matte Black**  
(2414024)  
125.0724.202
-  **Onyx**  
(2414025)  
125.0724.203
-  **Polar White**  
(2414026)  
125.0724.204

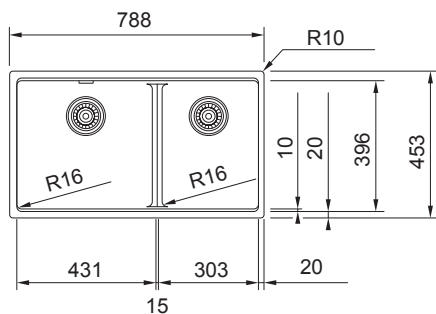

Stainless steel waste kits and overflows come standard with onyx and polar white sinks.

# Rapid

Topmount



## Available Accessory Packs

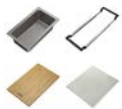

01

**2403079**

All-In

Accessory Pack

**LEGEND**



= Topmount



= Flushmount



= Undermount

SMART

01



Dimension **860 x 500mm**

Bowl Size **340 x 400 x 180mm**

Bowl Radius **70mm**

Cut-out Size **840 x 480mm**

Overflow **Yes**

**RPX 611-86**

Stainless Steel  
LHD: 101.0644.696  
(2008352)  
RHD: 101.0644.695  
(2008353)

**Left Hand Drainer (LHD) Model Shown**

Available in Right Hand Drainer (RHD) configuration.

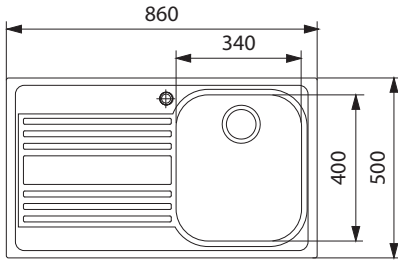

 AISI  
304

SMART

01



Dimension **1000 x 500mm**

Bowl 1 Size **340 x 400 x 180mm**

Bowl 2 Size **160 x 300 x 125mm**

Bowl Radius **70mm**

Cut-out Size **980 x 480mm**

Overflow **Yes**

**RPX 651**

Stainless Steel  
LHD: 101.0644.699  
(2008354)  
RHD: 101.0644.697  
(2008355)

**Left Hand Drainer (LHD) Model Shown**

Available in Right Hand Drainer (RHD) configuration.

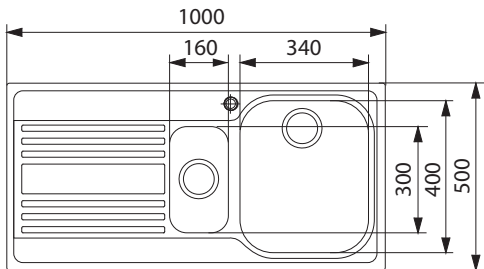

 AISI  
304

# Rapid

Topmount



## Available Accessory Packs

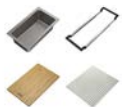

01

**2403079**

All-In

Accessory Pack

**LEGEND**



= Topmount



= Flushmount



= Undermount

SMART

01



Dimension **1160 x 500mm**

**RPX 621**

Bowl 1 Size **340 x 400 x 180mm**

Bowl 2 Size **340 x 400 x 180mm**

Stainless Steel

LHD: 101.0644.704  
(2008356)

RHD: 101.0644.702  
(2008357)

Bowl Radius **70mm**

Cut-out Size **1140 x 480mm**

Overflow **Yes**

**Left Hand Drainer (LHD) Model Shown**

Available in Right Hand Drainer (RHD) configuration.

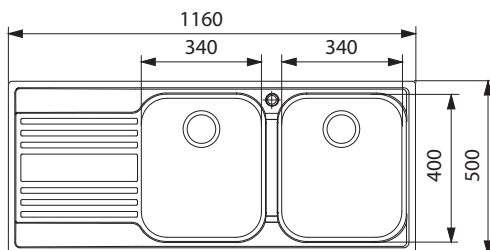

 AISI  
304



# Taps

Active Twist 82

Steel 84



# TAPS OVERVIEW

## Pull-Out Taps

MYTHOS

**ACTIVE TWIST TA7711**  
(2266987) 115.0710.429



**Pull-Out** | 5 star/6 Lpm

**ACTIVE TWIST TA7711MB**  
(2266988) 115.0710.521



**Pull-Out** | 5 star/6 Lpm

MARIS

**STEEL TA9631 (2265241)**  
115.0695.848



**Pull-Out** | 5 star/6 Lpm

**STEEL TA9631B (2265242)**  
115.0695.829



**Pull-Out** | 5 star/6 Lpm

**STEEL TA9631GD (2266986)**  
115.0736.455



**Pull-Out** | 5 star/6 Lpm

SMART



# WITH THE ACTIVE TWIST WE'VE LOOKED AT TAPS DIFFERENTLY

Think you know taps? Think again. Because with the Active Twist, we've created a tap that works differently; with the ability to not only fill the sink, but empty it too.

Alongside its stylish, minimalist looks, we've incorporated an innovative special feature that links tap and sink – a dial that when turned, operates the sink's waste outlet, so the water drains away, easily, safely and hygienically.



# CLEANER ON EVERY LEVEL

As well as meaning you no longer have to put your hands into hot or dirty water to empty the sink, the Active Twist can also help to create a cleaner look on the work surface, as there's no need to add a separate waste control.

Instead, it's an integral part of the tap.



## FRANKE ECO-CARTRIDGE

Designed to limit both the flow and temperature, the Franke ECO-Cartridge helps to actively save both water and energy.



# Active Twist



MYTHOS



Type **Pull-Out - Dual Spray**  
Spout **L-Spout**  
Spout Rotation **180° Swivel**  
Cut-out Size **Ø 35mm**  
WELS **5 star / 6 Lpm**  
WELS Registration **T44561**

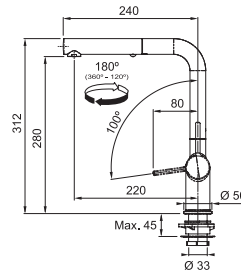

**TA7711 (2266987)**



**Brushed Chrome**  
115.0710.429

MYTHOS



Type **Pull-Out - Dual Spray**  
Spout **L-Spout**  
Spout Rotation **180° Swivel**  
Cut-out Size **Ø 35mm**  
WELS **5 star / 6 Lpm**  
WELS Registration **T44561**

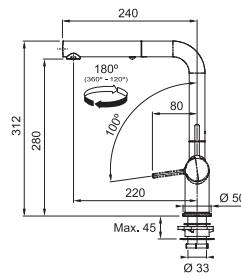

**TA7711MB (2266988)**



**Matte Black**  
115.0710.521

# Steel



MARIS



Type **Pull-Out - Dual Spray Spout J-Spout**  
Spout Rotation **180° Swivel**  
Cut-out Size **Ø 35mm**  
WELS **5 star / 6 Lpm**  
WELS Registration **TA42222**

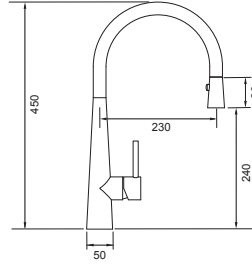

**TA9631 (2265241)**

 **Stainless Steel**  
115.0695.848

MARIS



Type **Pull-Out - Dual Spray Spout J-Spout**  
Spout Rotation **180° Swivel**  
Cut-out Size **Ø 35mm**  
WELS **5 star / 6 Lpm**  
WELS Registration **TA42222**

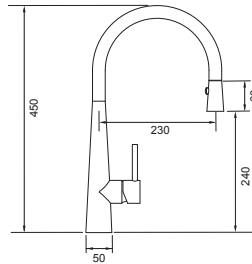

**TA9631B (2265242)**

 **Brushed Black**  
115.0695.829

MARIS



Type **Pull-Out - Dual Spray Spout J-Spout**  
Spout Rotation **180° Swivel**  
Cut-out Size **Ø 35mm**  
WELS **5 star / 6 Lpm**  
WELS Registration **TA42222**

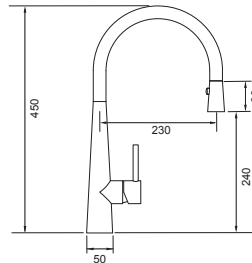

**TA9631GD (2266986)**

 **Brushed Gold**  
115.0736.455

## TAP WARRANTY NOTICE

Franke taps purchased through Reece have a full 5 years parts and labour warranty and a further 10 years applies to the cartridge only, plus any faults in product construction, materials and assembly.

Large and heavy taps should ideally be mounted directly through the solid benchtop or fully supported from underneath. For all other swivel taps, we recommend the use of the Franke Tap Support Arm (provided with tap). Please ensure all Franke tapware is installed at a pressure of no greater than 500 kPa in accordance with AS/NZS3500 and insist that your plumber flushes all of the water supply lines before installing tapware. Failure to do so may void warranty.

# Accessories

Plumbing Kits 88

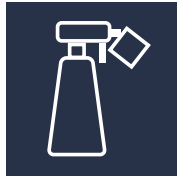



# Plumbing Kits





**Finish Grey Polypropylene**

**Description** The space saving solution for installing two and three bowl sinks into one flush fitted outlet, located at the rear of your cabinet. Includes connection points for appliances.

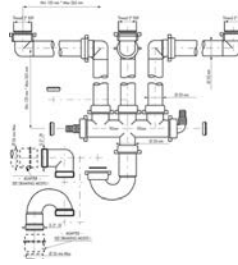

**SPAZIO  
PLUMBING KIT**

SPAZIO PK 945 (2029265)  
112.0058.945



**Finish Grey Polypropylene**

**Description** The space saving solution for installing two bowl sinks into one flush fitted outlet, located at the rear of your cabinet. Adjustable to any combination of bowl depth, ensuring maximum drainage is achieved.

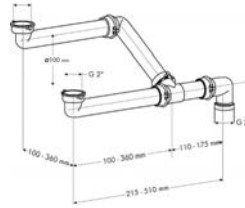

**ECO  
PLUMBING KIT**

ECO PK 205 (2028921)  
112.0189.205



**Franke declines all responsibility for any errors or inaccuracies and reserves the right to modify product specifications without prior notice.**



As our policy is one of continual improvement, the manufacturer reserves the right to alter specifications without notice.

**For our nearest bathroom showroom.  
AUS : Call 1800 032 566 or visit [reece.com.au](http://reece.com.au)**

Due to limitations in the printing process the colours in this brochure are a guide only.

The manufacturer/distributor reserves the right to vary specifications or delete models from their range without prior notification.

The manufacturer / distributor takes no responsibility for printing errors.

Franke sinks enjoy an extensive product warranty. Check product for details, terms and conditions apply. Domestic use only. See [www.reece.com.au/warranties](http://www.reece.com.au/warranties) for more information.

(BROCHURE CODE 9501714 V25)



**Franke Australia**

83 Bangholme Road  
Dandenong South  
VIC 3175, Australia

Phone +61 3 9700 9100

[www.franke.com](http://www.franke.com)

**April 2026**

